

## PROFILE D'EAU PLUVIALE / PROFILE RAINWATER

007.0729.XX

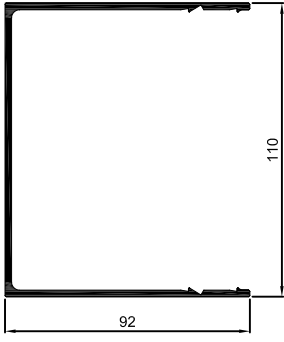

007.0730.XX

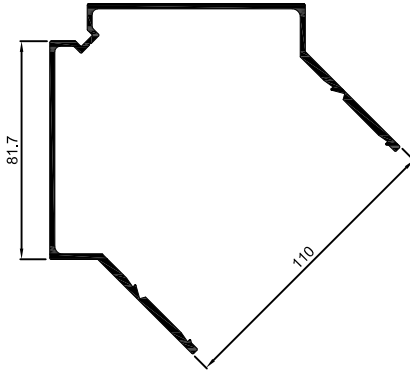

007.0731.XX

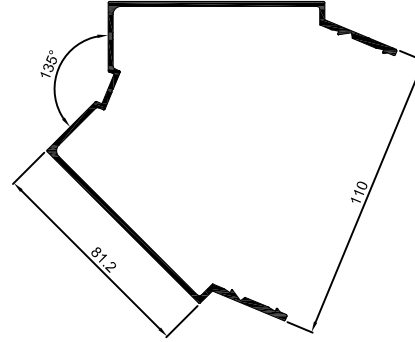

007.0735.XX\*

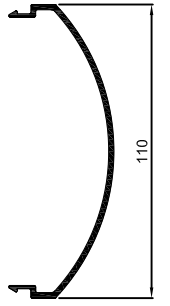

## PROFILE D'ANGLE - PROFILE DE RIVE - MENEAU / CORNER PROFILE - SKYLIGHT - SUSPENSION PROFILE

ANGLE / CORNER 90°

50 mm

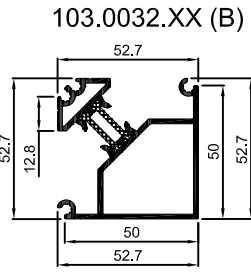

68 mm

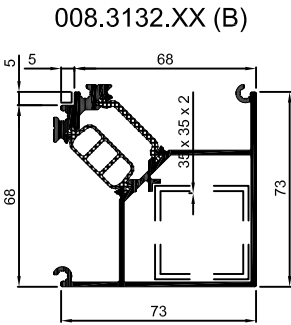

007.0751.XX (F)

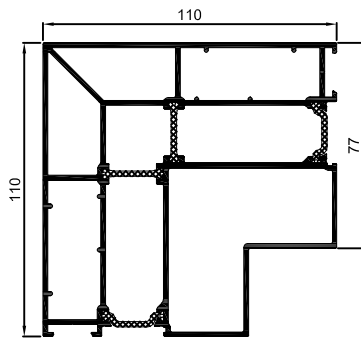

ANGLE / CORNER 135°

50 mm

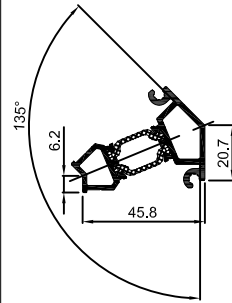

68 mm

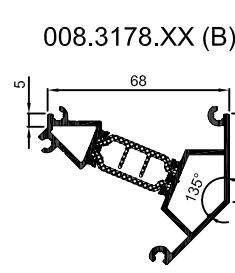

50 mm

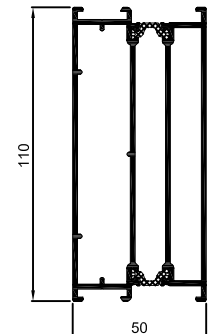

68 mm

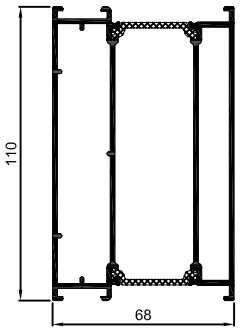

001.0897.XX (B)

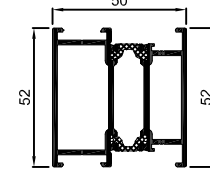

008.3897.XX (B)

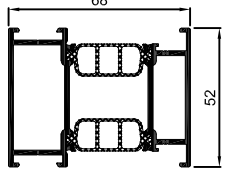

007.0564.PA

Angle variable - 50 mm

103.0121.XX (B)

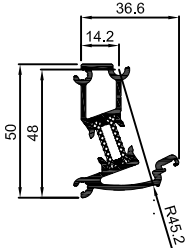

103.0122.XX (B)

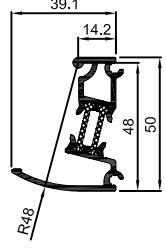

Angle variable - 68 mm

008.0021.XX (B)

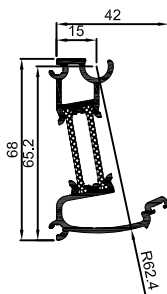

008.0022.XX (B)

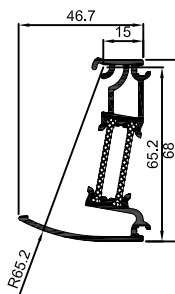

007.0726.XX

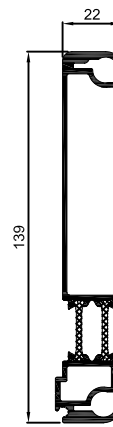

007.0562.PA

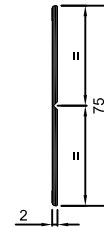

007.0563.PA

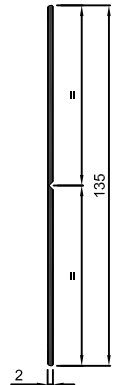

007.0844.XX

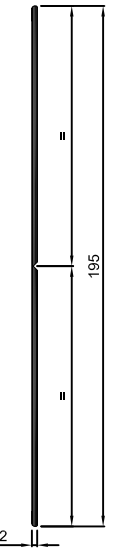
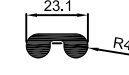

## PROFILE FAITIERE/ RIDGE PROFILE

007.1851.XX

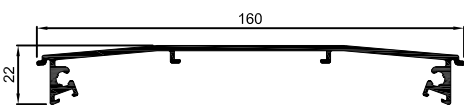

007.0838.00

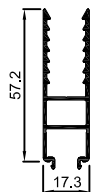

## PROFILE DE RECouvreMENT / COVERING PROFILE

007.0742.XX

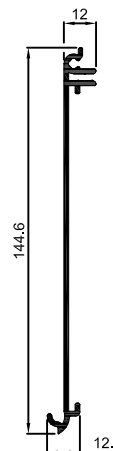

007.0741.XX

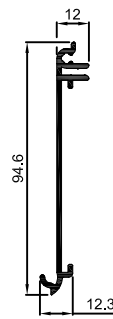

007.0744.XX

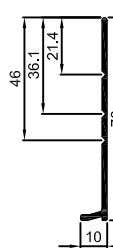

007.0759.XX

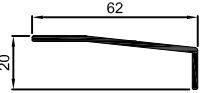

007.0740.XX (F)

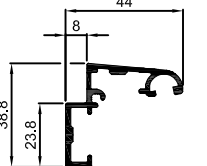

(F) : FLEXSTOCK / FLEXSTOCK

(B) BICOLORATION

### Siège social

1, rue Victor Cousin  
77127 LIEUSAIN  
Tél. : 01 64 13 85 95  
info.france@reynaers.com

### Agence Nord-Est • Paris

1, rue Victor Cousin  
77127 LIEUSAIN  
Tél. : 01 64 13 85 95

### Agence Sud-Est • Lyon

638 rue du chat botté  
01700 BEYNOST  
Tél. : 04 78 55 90 30

### Agence Nord-Ouest • Nantes

7, Bd Ampère - Bat. Sirius  
Espace Performance La fleuriaye  
44481 CARQUEFOU CEDEX  
Tél. : 02 28 01 44 44

### Agence Sud-Ouest • Bordeaux

218, avenue Jean Mermoz  
33320 EYSINES  
Tél. : 05 56 69 32 80

### Export - D.O.M. T.O.M. • Paris

1, rue Victor Cousin  
77127 LIEUSAIN  
Tél. : 01 64 13 85 72

## CHENEAUX / BOX GUTTER

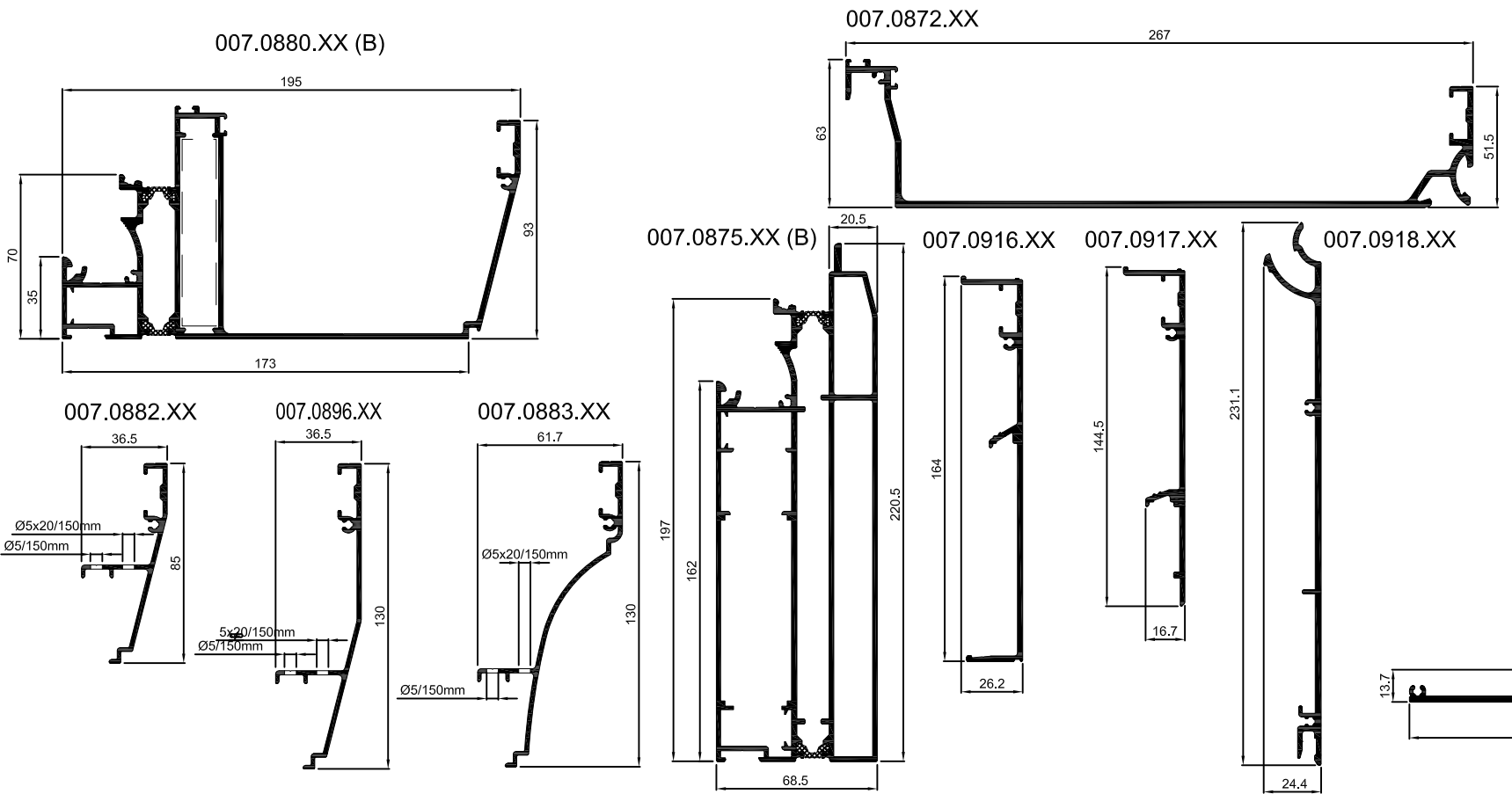

## PROFILE VERRIERE SKYLIGHT PROFILE

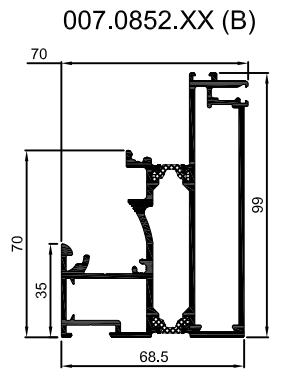

## OBTURATEUR / CONDENSATION

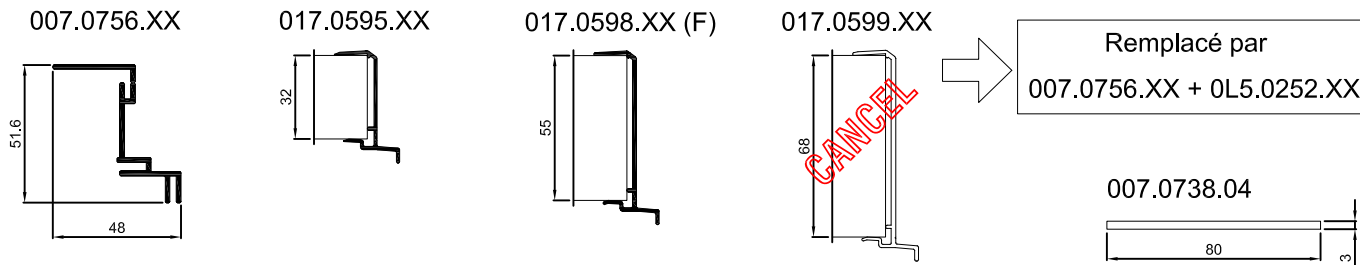

## TRAVERSE / TRANSOM

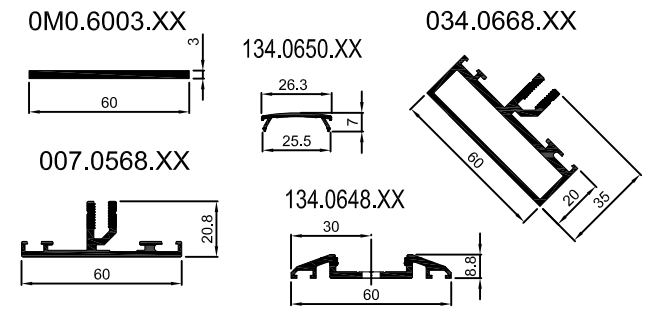

## PARCLOSE / GLAZING BEAD



## TABATIERE / ATTIC WINDOW

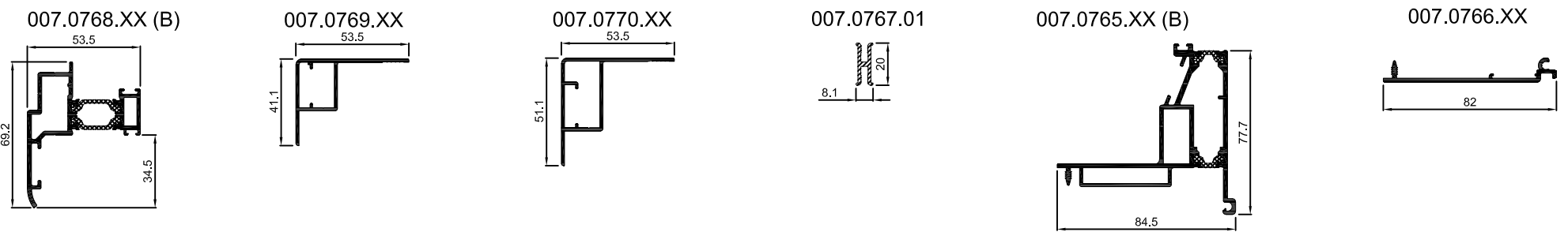

## DIVERS / MISCELLANEOUS

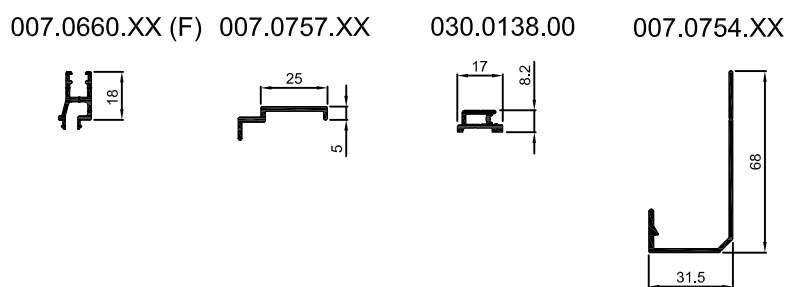

(B) BICOLORATION

(F) : FLEXSTOCK / FLEXSTOCK

## ISOLATEUR / INSULATOR

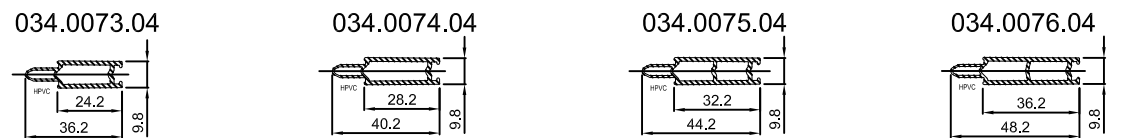

## REDUCTEUR DE FEUILLURE / FILLISTER REDUCER

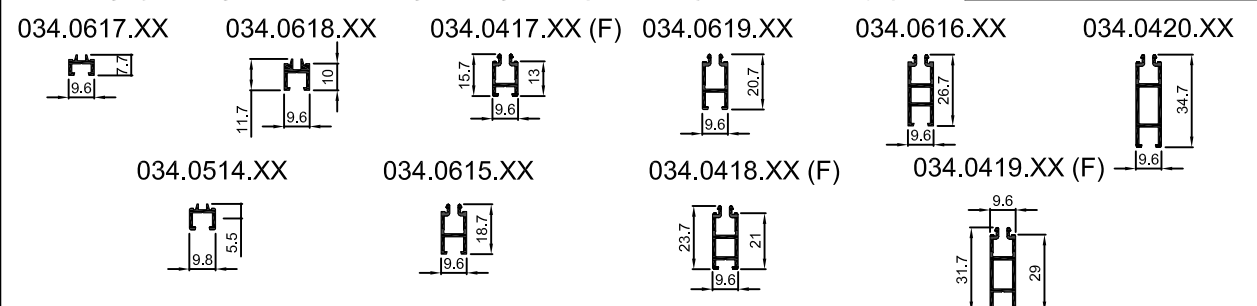

### Siège social

1, rue Victor Cousin  
77127 LIEUSAIN  
Tél. : 01 64 13 85 95  
info.france@reynaers.com

### Agence Nord-Est • Paris

1, rue Victor Cousin  
77127 LIEUSAIN  
Tél. : 01 64 13 85 95

### Agence Sud-Est • Lyon

638 rue du chat botté  
01700 BEYNOST  
Tél. : 04 78 55 90 30

### Agence Nord-Ouest • Nantes

7, Bd Ampère - Bat. Sirius  
Espace Performance La fleuriaye  
44481 CARQUEFOU CEDEX  
Tél. : 02 28 01 44 44

### Agence Sud-Ouest • Bordeaux

218, avenue Jean Mermoz  
33320 EYSINES  
Tél. : 05 56 69 32 80

### Export - D.O.M. T.O.M. • Paris

1, rue Victor Cousin  
77127 LIEUSAIN  
Tél. : 01 64 13 85 72