

TS 68 WINDOWS - OUTWARD OPENING

TS 68 GETEKEND
TS 68 DESSINE
TS 68 DRAWN
TS 68 GEZEICHENET

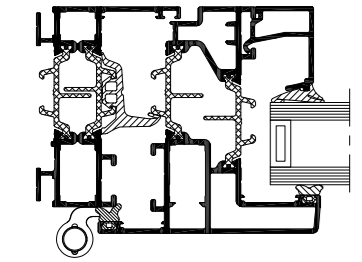

ISOLATIE VARIANT TS 68
ISOLATION VARIANTE TS 68
INSULATION VARIANT TS 68
ISOLATION VARIANTE TS 68

TS 68 STANDARD

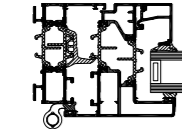

TS 68-HI

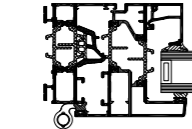

TS 68-HI+

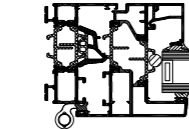

TS 68-HI+

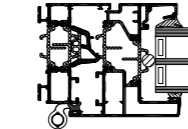

OVERZICHT OPENINGS TYPES
APERÇU TYPES D'OUVERTURE
OVERVIEW OPENING TYPES
ÜBERSICHT ÖFFNUNGSARTEN

VAST RAAM
FENÊTRE FIXE
FIXED WINDOW
FESTVERGLASUNG

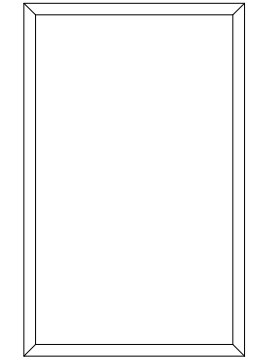

1a

OPENGAAND RAAM
FENÊTRE OUVRANT
OPENING WINDOW
AUFGEHENDES FENSTER

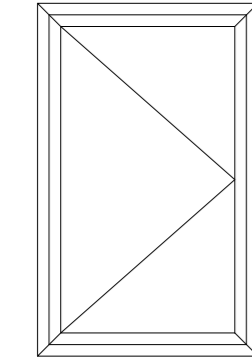

2a

STOLPRAAM
FENÊTRE DOUBLE OUVRANT
DOUBLE CASEMENT WINDOW
STULP-DREHFENSTER

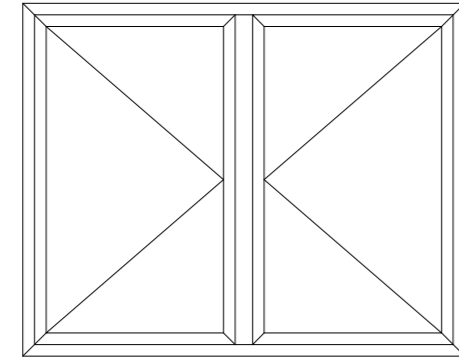

3a

XXX
FENÊTRE A L'ITALIENNE
OFF SET HORIZONTAL PIVOT WINDOW
XXX

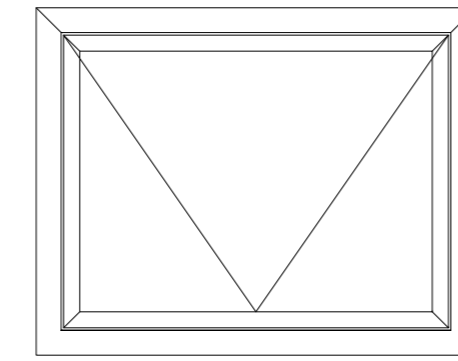

4a

PROFIELOVERZICHT
APERÇU DES PROFILES
PROFILE OVERVIEW
PROFILUEBERSICHT

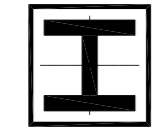

HULPPROFIELEN
PROFILES COMPLEMENTAIRES
ADDITIONAL PROFILES
ZUSATZPROFILE



TS 68 Window_Additional profiles.dwg

BOUWAANSLUITINGEN
RACCORDEMENTS AU BATIMENT
BUILDING CONNECTIONS
BAUANSCHLUESSE



TS 68 Window_Building Connection.dwg

1a

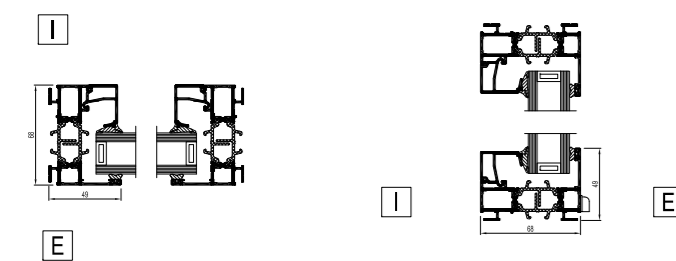
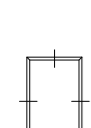

VARIANT / VARIANTE

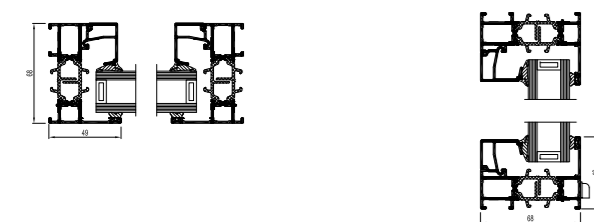

2a

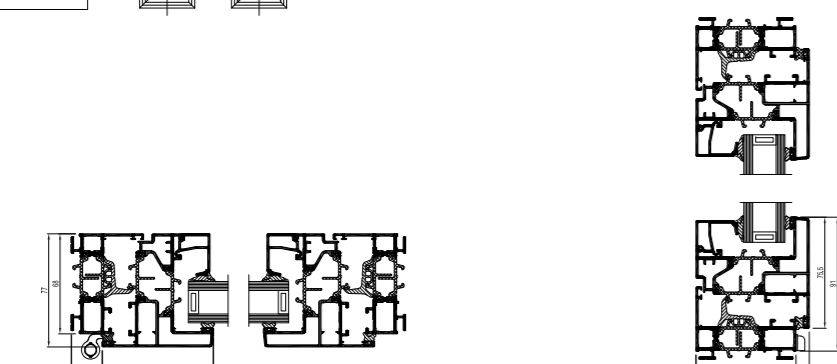
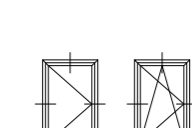

VARIANT / VARIANTE

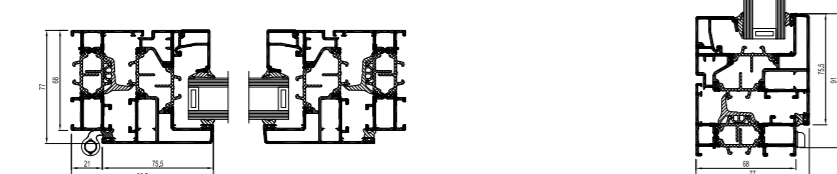

3a

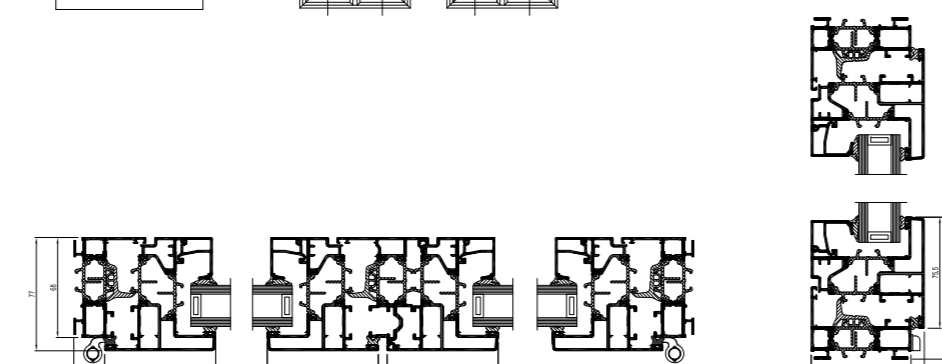
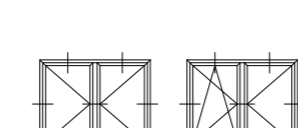

VARIANT / VARIANTE

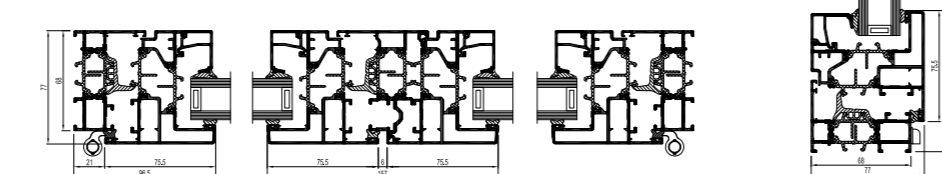

4a

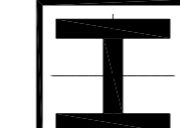
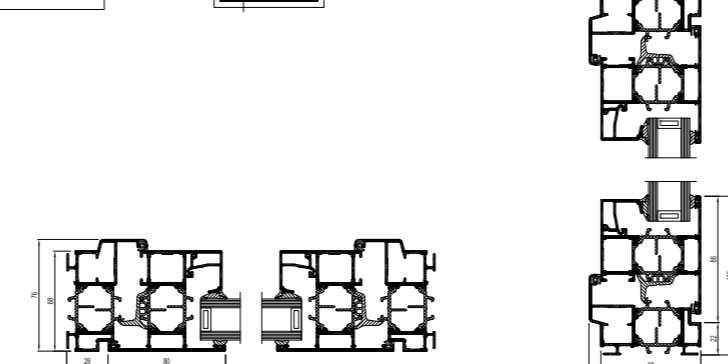
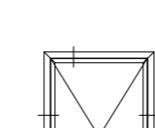

PROFIELOVERZICHT
APERÇU DES PROFILES
PROFILE OVERVIEW
PROFILUEBERSICHT

BUITENKADER
DORMANT
OUTER FRAME
BLENDRAHMEN

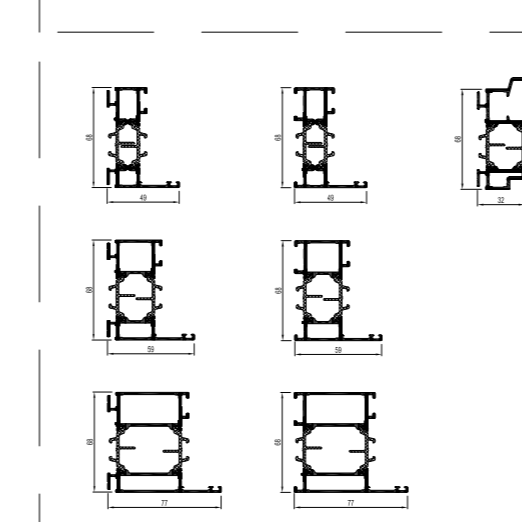

VLEUGEL
OUVRANT
VENT
FLÜGEL

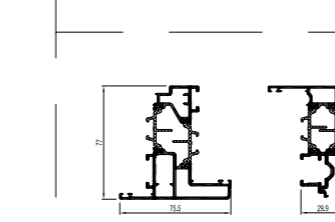

DOUBLE CASEMENT
BATTEMENT RAPPORTE
DOUBLE CASEMENT
DOUBLE CASEMENT

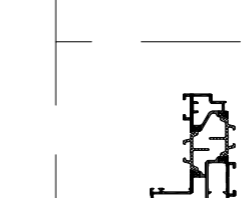

DE PROFIELKEUZE WORDT BEPAALD DOOR DE MAXIMALE AFMETINGEN EN HET MAXIMALE GEWICHT VAN HET ELEMENT.
NEEM CONTACT OP MET UW REYNAERS ALUMINIUM FABRIKANT OM DE JUISTE PROFIELKEUZE TE BEVESTIGEN.

LE CHOIX DU PROFILÉ EST DÉFINI PAR LES DIMENSIONS MAXIMALES ET LE POIDS MAXIMUM DE L'ÉLÉMENT.
VEUILLEZ CONTACTER VOTRE FABRICANT REYNAERS ALUMINIUM POUR CONFIRMER LE BON CHOIX DE PROFILÉ.

THE PROFILE SELECTION IS DEFINED BY THE MAXIMUM DIMENSIONS AND WEIGHT OF THE ELEMENT.
PLEASE CONTACT YOUR REYNAERS ALUMINIUM FABRICATOR TO CONFIRM THE RIGHT PROFILE SELECTION.

DIE PROFILAUSWAHL WIRD DURCH DIE MAXIMALEN ABMESSUNGEN UND DAS GEWICHT DES ELEMENTS DEFINIERT.
BITTE WENDEN SIE SICH AN IHREN REYNAERS ALUMINIUM HERSTELLER UM DEN RICHTIGEN PROFILAUSWAHL ZU BESTÄTIGEN.